



SERIES: PQDE6W-T | DESCRIPTION: DC-DC CONVERTER

FEATURES

- industry standard footprint
- high efficiency up to 88%
- single and dual output models available
- chassis mount
- 1500 Vdc isolation
- industrial operating temp -40~+85 °C
- 4:1 wide input range
- input under voltage protection & over voltage protection
- over current protection



MODEL	input voltage		output voltage (Vdc)	output current		output power max (W)	ripple & noise ¹ max (mVp-p)	efficiency ² typ (%)
	typ (Vdc)	range (Vdc)		min (mA)	max (mA)			
PQDE6W-Q24-S3-T	24	10~36	3.3	0	1500	4.95	85	79
PQDE6W-Q24-S5-T	24	10~36	5	0	1200	6	85	83
PQDE6W-Q24-S9-T	24	10~36	9	0	667	6	85	85
PQDE6W-Q24-S12-T	24	10~36	12	0	500	6	85	87
PQDE6W-Q24-S15-T	24	10~36	15	0	400	6	85	88
PQDE6W-Q24-S24-T	24	10~36	24	0	250	6	85	88
PQDE6W-Q24-D5-T	24	10~36	±5	0	±600	6	85	83
PQDE6W-Q24-D12-T	24	10~36	±12	0	±250	6	85	87
PQDE6W-Q24-D15-T	24	10~36	±15	0	±200	6	85	88
PQDE6W-Q24-D24-T	24	10~36	±24	0	±125	6	85	88
PQDE6W-Q48-S3-T	48	19~75	3.3	0	1500	4.95	85	79
PQDE6W-Q48-S5-T	48	19~75	5	0	1200	6	85	83
PQDE6W-Q48-S12-T	48	19~75	12	0	500	6	85	87
PQDE6W-Q48-S15-T	48	19~75	15	0	400	6	85	88
PQDE6W-Q48-S24-T	48	19~75	24	0	250	6	85	88
PQDE6W-Q48-D5-T	48	19~75	±5	0	±600	6	85	83
PQDE6W-Q48-D12-T	48	19~75	±12	0	±250	6	85	87
PQDE6W-Q48-D15-T	48	19~75	±15	0	±200	6	85	88

Notes: 1. From 5~100% load, nominal input, 20 MHz bandwidth oscilloscope, with 10 µF tantalum and 1 µF ceramic capacitors on the output. From 0~5% load, ripple and noise is <5% Vo.

2. Measured at nominal input voltage, full load.

3. All specifications are measured at Ta=25°C, humidity < 75%, nominal input voltage, and rated output load unless otherwise specified.

PART NUMBER KEY

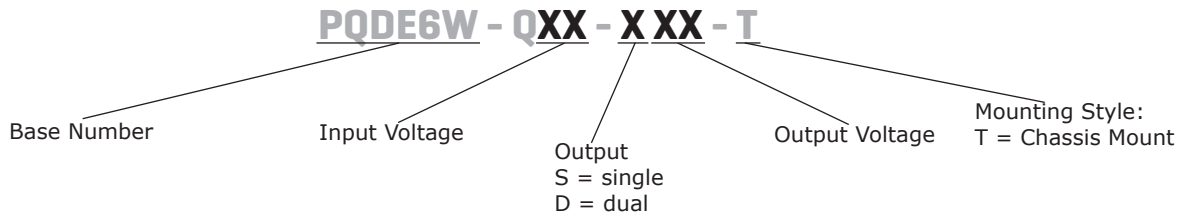

INPUT

parameter	conditions/description	min	typ	max	units
operating input voltage	24 Vdc input models	10	24	36	Vdc
	48 Vdc input models	19	48	75	Vdc
start-up voltage	24 Vdc input models			10	Vdc
	48 Vdc input models			19	Vdc
surge voltage	for maximum of 1 second				
	24 Vdc input models	-0.7		50	Vdc
	48 Vdc input models	-0.7		100	Vdc
under voltage shutdown	24 Vdc input models	5.5	6.5		Vdc
	48 Vdc input models	12	15.5		Vdc
current	24 Vdc input models			268	mA
		3.3 Vdc output models		309	mA
		all other models			
	48 Vdc input models			134	mA
		3.3 Vdc output models		155	mA
		all other models			
filter	Pi filter				
input reverse polarity protection	yes				
no load power consumption			0.12		W

OUTPUT

parameter	conditions/description	min	typ	max	units
maximum capacitive load ¹	3.3 Vdc output models			1,800	μF
	5 Vdc output models			1,000	μF
	9 Vdc output models			680	μF
	12, ±5 Vdc output models			470	μF
	15 Vdc output models			220	μF
	all other models			100	μF
voltage accuracy ²	0% to full load		±1	±3	%
line regulation	from low line to high line, full load				
	positive outputs		±0.2	±0.5	%
	negative outputs		±0.5	±1	%
load regulation ³	from 5% to full load				
	positive outputs		±0.5	±1	%
	negative outputs		±0.5	±1.5	%
voltage balance ⁴	dual output models			±5	%
cross regulation	dual output models: main output 50% load secondary output from 10~100% load			±5	%
switching frequency ⁵	PWM mode		300		kHz
transient recovery time	25% load step change, nominal input voltage		300	500	μs

- Note:
1. Tested at input voltage range and full load.
 2. At 0~5% load, the max output voltage accuracy for the ±5 & ±9 Vdc output models is ±5%.
 3. At 0~100% load, the max load regulation is ±5%.
 4. Unbalanced loads should not exceed ±5%. If ±5% is exceeded, the product performance cannot be guaranteed.
 5. Value is based on full load. At loads <50%, the switching frequency decreases with decreasing load.

OUTPUT (CONTINUED)

parameter	conditions/description	min	typ	max	units
transient response deviation	25% load step change, nominal input voltage		±5	±8	%
	3.3, 5, ±5 Vdc output models all other models		±3	±5	%
temperature coefficient	at full load			±0.03	%/°C

PROTECTIONS

parameter	conditions/description	min	typ	max	units
over voltage protection		110		160	%
over current protection		110	140	190	%
short circuit protection	continuous, self recovery				

SAFETY AND COMPLIANCE

parameter	conditions/description	min	typ	max	units
isolation voltage	input to output for 1 minute at 1 mA	1,500			Vdc
isolation resistance	input to output at 500 Vdc	1,000			MΩ
isolation capacitance	input to output, 100 kHz / 0.1 V		1,000		pF
conducted emissions	CISPR22/EN55022, class A (no external circuit); class B (external circuit required, see Figure 3-b)				
radiated emissions	CISPR22/EN55022, class A (no external circuit); class B (external circuit required, see Figure 3-b)				
ESD	IEC/EN61000-4-2, contact ± 4kV, class B				
radiated immunity	IEC/EN61000-4-3, 10V/m, class A				
EFT/burst	IEC/EN61000-4-4, ± 2kV, class B (external circuit required, see Figure 3-a)				
surge	IEC/EN61000-4-5, line-line ± 2kV, class B (external circuit required, see Figure 3-a)				
conducted immunity	IEC/EN61000-4-6, 3 Vr.m.s, class A				
voltage dips & interruptions	IEC/EN61000-4-29, 0%-70%, class B				
MTBF	as per MIL-HDBK-217F, 25°C	1,000,000			hours
RoHS	2011/65/EU				

ENVIRONMENTAL

parameter	conditions/description	min	typ	max	units
operating temperature	see derating curve	-40		85	°C
storage temperature		-55		125	°C
storage humidity	non-condensing	5		95	%
vibration	10~55 Hz for 30 minutes on each axis		10		G

MECHANICAL

parameter	conditions/description	min	typ	max	units
dimensions	76.00 x 31.50 x 21.20 [2.992 x 1.240 x 0.835 inch]				mm
case material	aluminum alloy				
weight			36		g

MECHANICAL DRAWING

units: mm [inch]
tolerance: ±0.50[±0.020]

wire range: 24~12 AWG
tightening torque: max 0.4 N*m

PIN CONNECTIONS		
PIN	Function	
	Single	Dual
1	NC	NC
2	GND	GND
3	Vin	Vin
4	0V	-Vout
5	NC	0V
6	+Vout	+Vout

NC=no connection

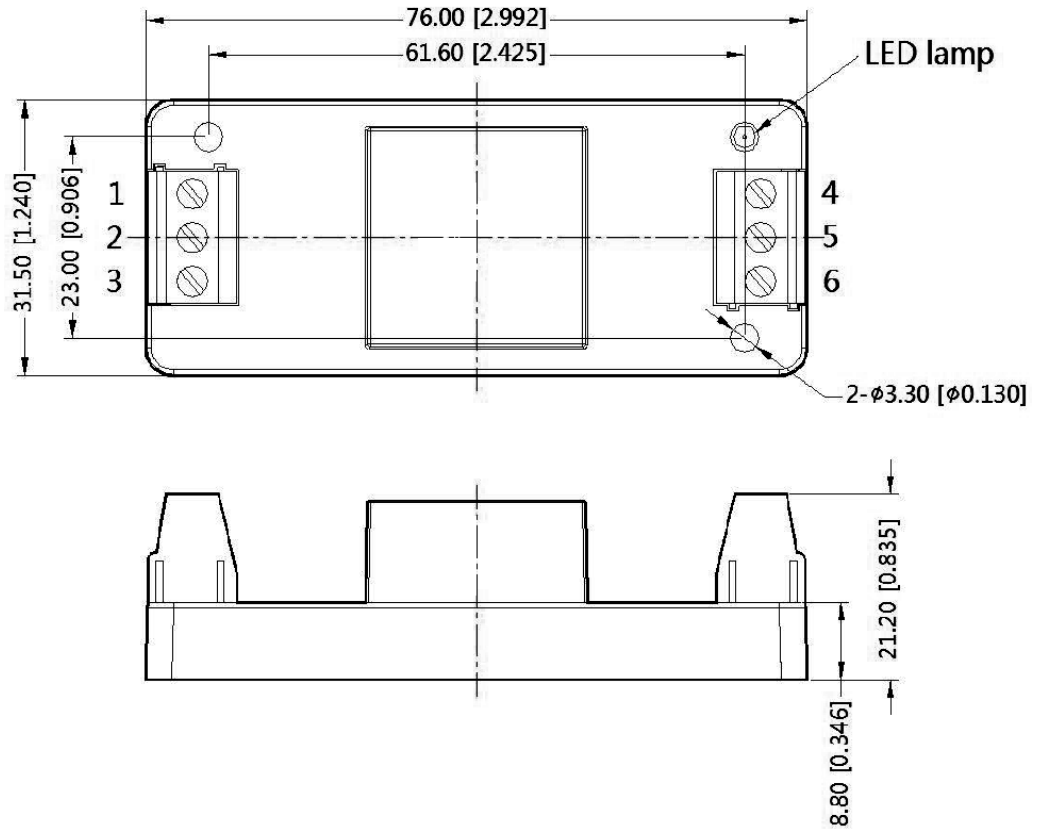

DERATING CURVE

Temperature Derating Curve
(Natural Convection)

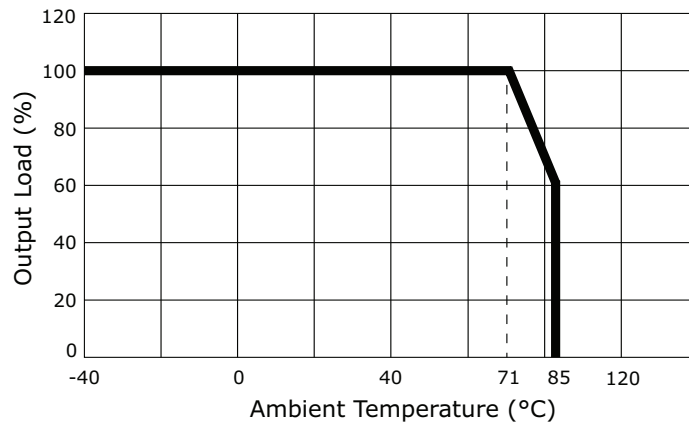

APPLICATION CIRCUIT

This series has been tested according to the following recommended circuits (Figures 1 & 2) before leaving the factory. If you want to further reduce the input and output ripple, you can increase the input and output capacitors or select capacitors of low equivalent impedance provided that the capacitance is less than the maximum capacitive load of the model.

Figure 1
Single Output Models

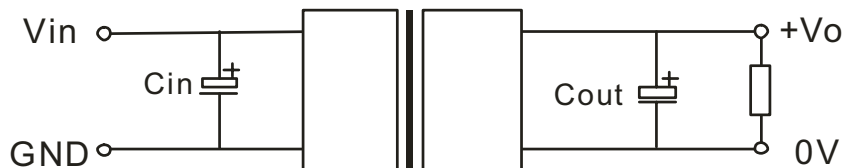
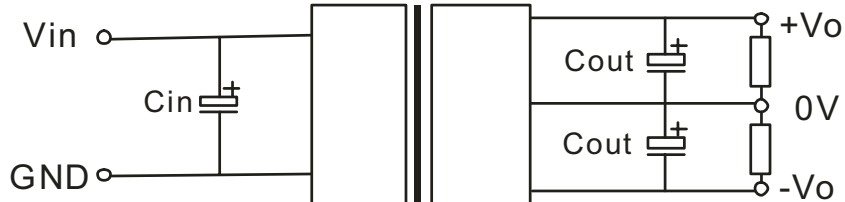

Table 1

Vin (Vdc)	Cin (μF)	Cout (μF)
24	100	10
48	10~47	10

Figure 2
Dual Output Models



EMC RECOMMENDED CIRCUIT

Figure 3

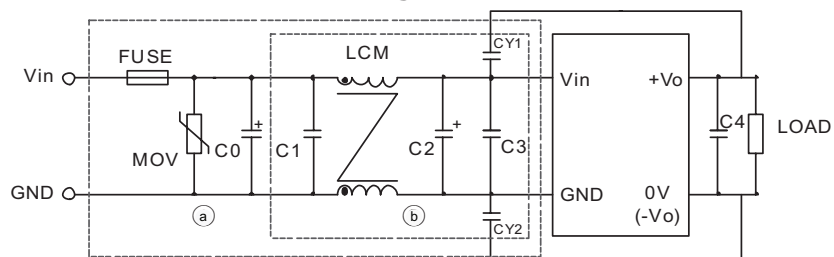

Table 2

Recommended External Circuit Components		
Vin (Vdc)	24	48
FUSE	choose according to actual input current	
MOV	S20K30	S14K60
C0	680 μF / 50 V	680 μF / 100 V
C1	1 μF / 50 V	1 μF / 100 V
C2	330 μF / 50 V	330 μF / 50 V
C3	4.7 μF / 50 V	4.7 μF / 100 V
C4	10 μF	
LCM	4.7 mH	
CY1, CY2	1 nF / 2 kV	

PACKAGING

units: mm

Inner Carton Size: 370 x 350 x 115 mm

Outer Carton Size: 400 x 365 x 255 mm

Outer Carton QTY: 96 pcs

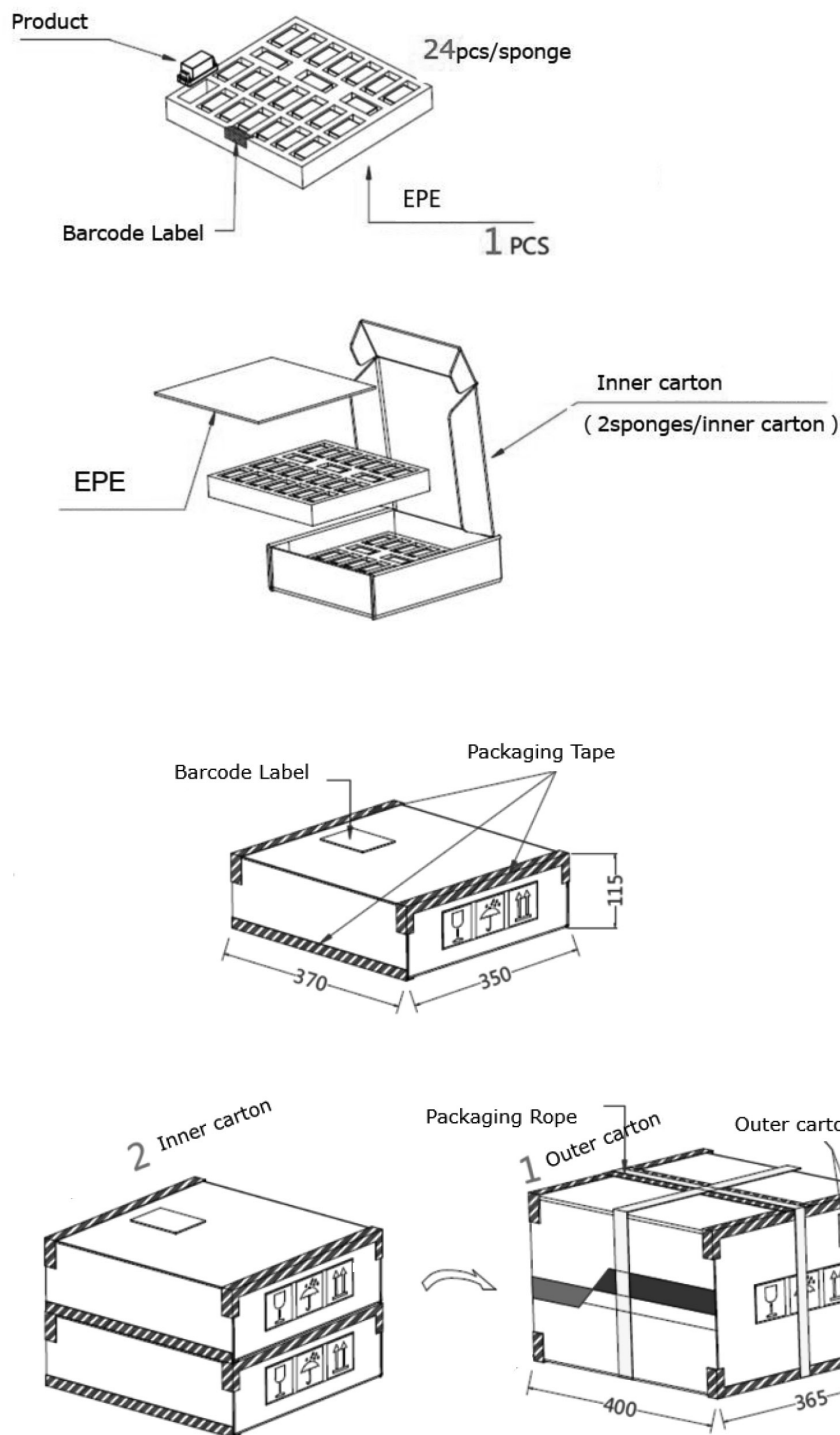

REVISION HISTORY

rev.	description	date
1.0	initial release	02/20/2018
1.01	updated datasheet	08/07/2018

The revision history provided is for informational purposes only and is believed to be accurate.

**CUI INC**[®]

Headquarters
20050 SW 112th Ave.
Tualatin, OR 97062
800.275.4899

Fax 503.612.2383
cui.com
techsupport@cui.com

CUI offers a two (2) year limited warranty. Complete warranty information is listed on our website.

CUI reserves the right to make changes to the product at any time without notice. Information provided by CUI is believed to be accurate and reliable. However, no responsibility is assumed by CUI for its use, nor for any infringements of patents or other rights of third parties which may result from its use.

CUI products are not authorized or warranted for use as critical components in equipment that requires an extremely high level of reliability. A critical component is any component of a life support device or system whose failure to perform can be reasonably expected to cause the failure of the life support device or system, or to affect its safety or effectiveness.